

The Northeast Region Tour

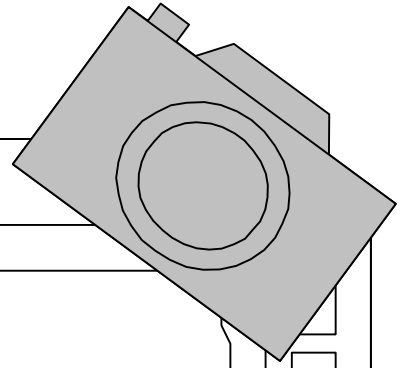









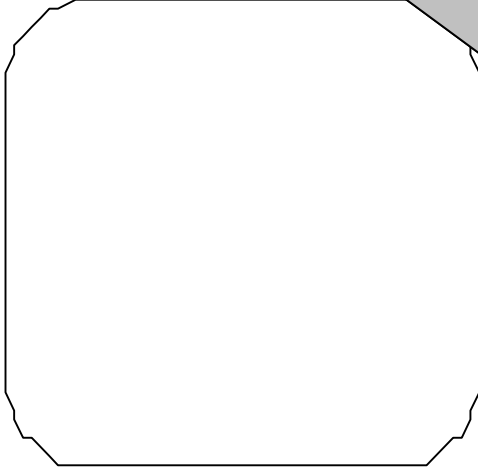





















By: _____



Stop 1: _____

Stop 2: _____

Stop 3: _____

The Southern Region Tour





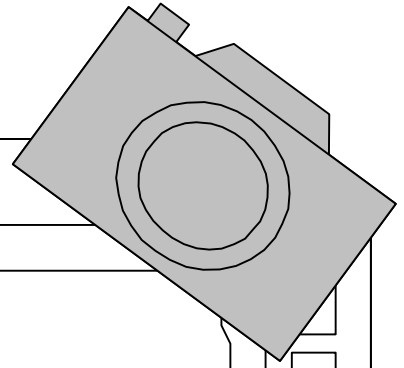





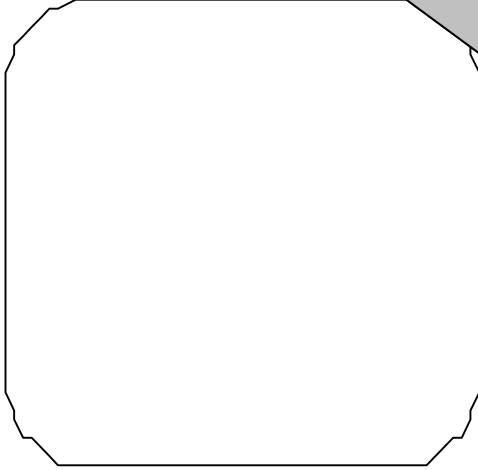
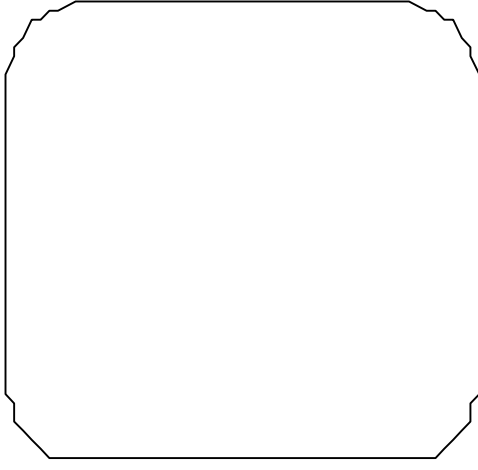
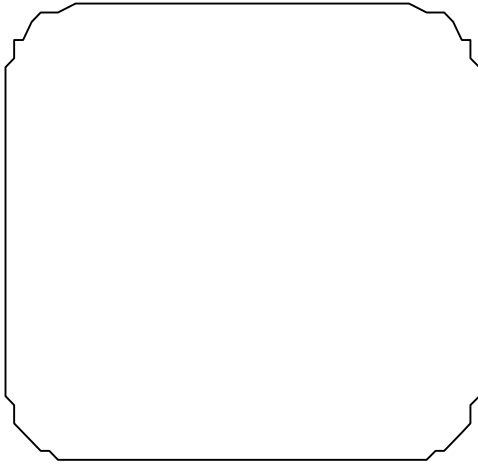



















By: _____



Stop 1: _____

Stop 2: _____

Stop 3: _____

The Western Region Tour





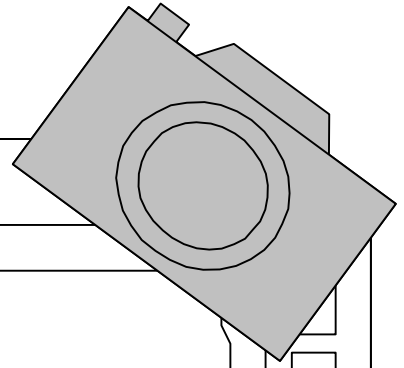





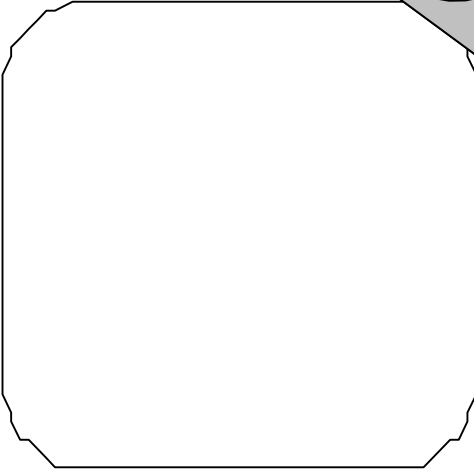
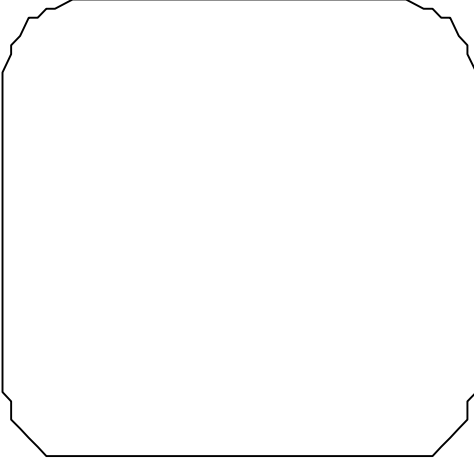
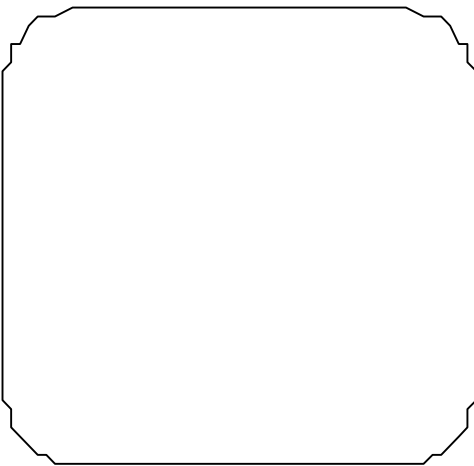





















By: _____



Stop 1: _____

Stop 2: _____

Stop 3: _____

The Midwest Region Tour

By: _____

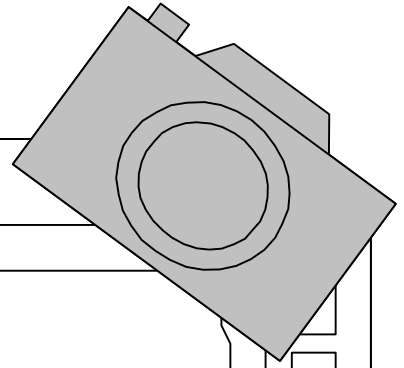

Stop 1: _____

Stop 2: _____

Stop 3: _____

